

Clarke[®]

CONTRACTOR[®]



50L 110V INDUSTRIAL DEHUMIDIFIER

MODEL NO: IDH50L110V

PART NO: 6470612

OPERATION & MAINTENANCE INSTRUCTIONS



DL0522 Iss 1

INTRODUCTION

Thank you for purchasing this CLARKE 50 Litre 110V Industrial Dehumidifier.

Before attempting to use this product, please read this manual thoroughly and follow the instructions carefully. In doing so you will ensure the safety of yourself and that of others around you, and you can look forward to your purchase giving you long and satisfactory service.

GUARANTEE

This product is guaranteed against faulty manufacture for a period of 12 months from the date of purchase. Please keep your receipt which will be required as proof of purchase.

This guarantee is invalid if the product is found to have been abused or tampered with in any way, or not used for the purpose for which it was intended.

Faulty goods should be returned to their place of purchase, no product can be returned to us without prior permission.

This guarantee does not effect your statutory rights.

ENVIRONMENTAL RECYCLING POLICY



Recycle unwanted materials instead of disposing of them as waste. All unwanted accessories and packaging should be sorted and taken to a recycling centre for disposal in a manner which is compatible with the environment.



By purchasing this product, the customer is taking on the obligation to deal with its safe disposal in accordance with the Waste Electrical and Electronic Equipment regulations (WEEE).

In effect, this means that this product must not be disposed of with general household waste. It must be disposed of according to the laws governing Waste Electrical and Electronic Equipment (WEEE) at a recognised disposal facility.

R290 is a refrigerant that complies with EEC environmental standards; nonetheless, the refrigerant circuit on the machine should not be punctured. At the end of its working life, consign the dehumidifier unit to a special collection centre.

ELECTRICAL CONNECTIONS



WARNING! READ THESE ELECTRICAL SAFETY INSTRUCTIONS THOROUGHLY BEFORE CONNECTING THE PRODUCT TO THE POWER SUPPLY.

Before switching the product on, make sure that the voltage of your electricity supply is the same as that indicated on the rating plate. Connecting it to any other power source may cause damage.

If the plug has to be changed due to damage, a replacement should be fitted, following the wiring instructions shown below. The old plug must be disposed of as insertion into a 110v socket could cause an electrical hazard.



WARNING: THE WIRES IN THE 3 CORE POWER CABLE OF THIS PRODUCT ARE COLOURED IN ACCORDANCE WITH THE FOLLOWING CODE: BLUE = NEUTRAL, BROWN = LIVE, YELLOW/GREEN = EARTH

If the colours of the wires in the power cable of this product do not correspond with the markings on the terminals of your plug, proceed as follows.

- The **Blue** wire must be connected to the terminal which is marked **N** or **Neutral**.
- The **Brown** wire must be connected to the terminal which is marked **L** or **Live**.
- The **Yellow/Green** wire must be connected to the terminal which is marked **E** or **Earth**.

If in any doubt, consult a qualified electrician. **DO NOT** attempt any repairs yourself.

Plug must be BS60309 approved.

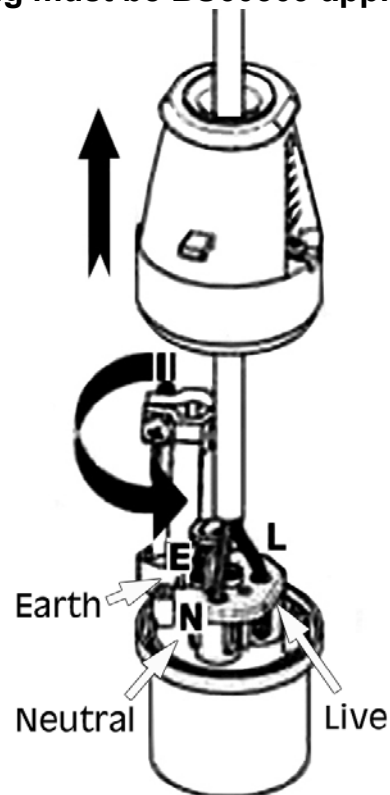

OVERVIEW



No.	Description
1	Handle
2	Control Panel
3	2 x Wheels
4	Continuous Drainage Pipe Outlet Hole
5	2 x Feet
6	5 Litre Internal Water Tank
7	Air Inlet and Carbon Air Filter
8	Carbon Air Filter Pull Tab

Contents List: 1 x 50L Dehumidifier, 2 x Wheels, 1 x Wheel Axle Rod (Inc: Nuts & Washers), 4 x Axle Fixing Screws, 1 x Drainage Pipe

SAFETY WARNINGS



WARNING: IF THE SUPPLY CABLE IS DAMAGED, IT MUST BE REPLACED BY THE MANUFACTURER, ITS SERVICE AGENT OR SIMILARLY QUALIFIED PERSONS IN ORDER TO AVOID A HAZARD.

1. Please read these instructions carefully and retain for future reference.
2. Position the mains cable so that it cannot be inadvertently pulled or pinched and where it does not cause a trip hazard.
3. This appliance is designed to dehumidify industrial environments and **MUST NOT** be used for other purposes.
4. If the appliance requires repair, **ALWAYS** contact your CLARKE dealer. **ALWAYS** insist on original spare parts. Repairs carried out by unauthorized persons may be dangerous and invalidate the guarantee.
5. Children **SHOULD NOT** play with the appliance. Cleaning and user maintenance **SHOULD NOT** be undertaken by children.
6. Before cleaning or maintenance operations, **ALWAYS** unplug the appliance from the power supply.
7. **DO NOT** move the appliance by pulling the power cable.
8. **DO NOT** install the appliance in rooms containing gas, oil or fuel.
9. **DO NOT** install near sources of heat.
10. **DO NOT** use the appliance on inclined surfaces.
11. Keep the appliance away from inflammable substances (alcohol etc) or pressurised containers (e.g. aerosol cans).
12. **DO NOT** rest heavy or hot objects on top of the appliance.
13. **ALWAYS** transport the appliance upright. **Wait at least 1 hour after transporting the appliance before using it to allow the refrigerant gasses to settle.**
14. **DO NOT** use the appliance outdoors.
15. **DO NOT** obstruct the air inlet or outlet.
16. **DO NOT** use means to accelerate the defrosting process or to clean, other than those recommended in this manual.
17. **DO NOT** store in a room continuously operating ignition sources like open flames, operating gas appliance or electric heater.
18. **DO NOT** cover the dehumidifier when in use. Place at least 50cm (100cm from front) from walls, doors, windows or obstructions.



WARNING: DO NOT USE OR STORE THE DEHUMIDIFIER NEAR A HEAT SOURCE, AS THE UNIT CONTAINS PRESSURISED FLAMMABLE REFRIGERANT GAS (R290-HYDROCARBON PROPANE)

R290 REFRIGERANT GAS (HYDROCARBON PROPANE)



H220: Extremely Flammable Gas.



H280: Contains Gas Under Pressure, May Explode if Heated.



R290 refrigerant gas complies with UK & European environmental directives.

R290 has a low GWP (Global Warming Potential) of 3 and CO₂ equivalent to 0.0006t

The dehumidifier contains approximately 200g of R290 refrigerant gas. The refrigerant system **MUST NOT** be perforated or punctured.

- **DO NOT** use or store in an unventilated space with an area smaller than 4m² per unit. The room must be such as to prevent stagnation of possible leaks of refrigerant gas as there could be a danger of fire or explosion hazard should the refrigerant come into contact with electric heaters, stoves or other sources of ignition.
- Refrigerant gas may be odourless.
- **DO NOT** use the product and contact the retailer for advice if damage has occurred to the unit which may have compromised the refrigerant system.
- Any repairs or maintenance must only be carried out on the unit by a suitably qualified engineer. Before opening and servicing the unit, the authorized engineer must be in possession of a copy of the manufacturer's service manual and must follow the safety information contained within it to ensure all hazards are minimized.

SAFETY SYMBOLS

	Read the manual and safety instructions before use		Do not cover when in use
	Indoor use only		Warning: Risk of Fire, Flammable Gas (R290)

TECHNICAL SPECIFICATION

Power Source	AC 110V
Input Current @ Rated Load	7.4A @ 30°C RH 80%, 5.5A @ 27°C RH 60%
Power	800W @ 30°C RH 80%, 600W @ 27°C RH 60%
IP Rating	IP22
Dehumidifying Extraction Rate	50 litres/day @ 30°C RH 80% 30 litres/day @ 27°C RH 60%
Suction Pressure (Low - High)	0.4Mpa - 1.0Mpa
Discharge Pressure (Low - High)	1.5Mpa - 2.5Mpa
Max. Air Flow Rate	300m ³ /h
Working Space	50 - 120m ³
Operating Temperature	5°C - 35°C
Refrigerant	200g of R290 (Hydrocarbon Propane)
Weight	30kg
Dimensions (DxWxH)	Handle Down: 480mm x 450mm x 655mm Handle Up: 480mm x 450mm x 900mm

ASSEMBLY

HANDLE

1. Place the machine in the upright position, Lift the handle on the rear of the machine by 180 degrees to the upright position.
2. Secure the handle in position using the screws provided.

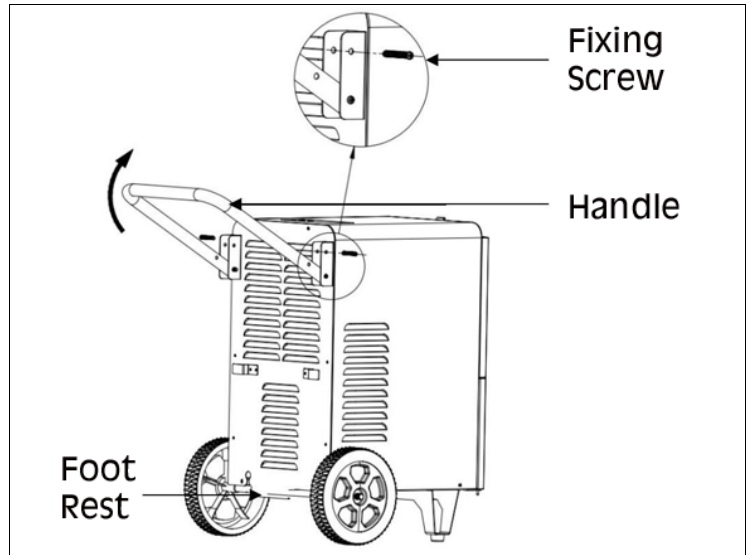

WHEELS

1. Incline the machine body, as shown, and fix the wheel axle on the bottom of the machine body using the 4 screws.
2. Using the nuts and washers, fix the wheels to the axle rod.

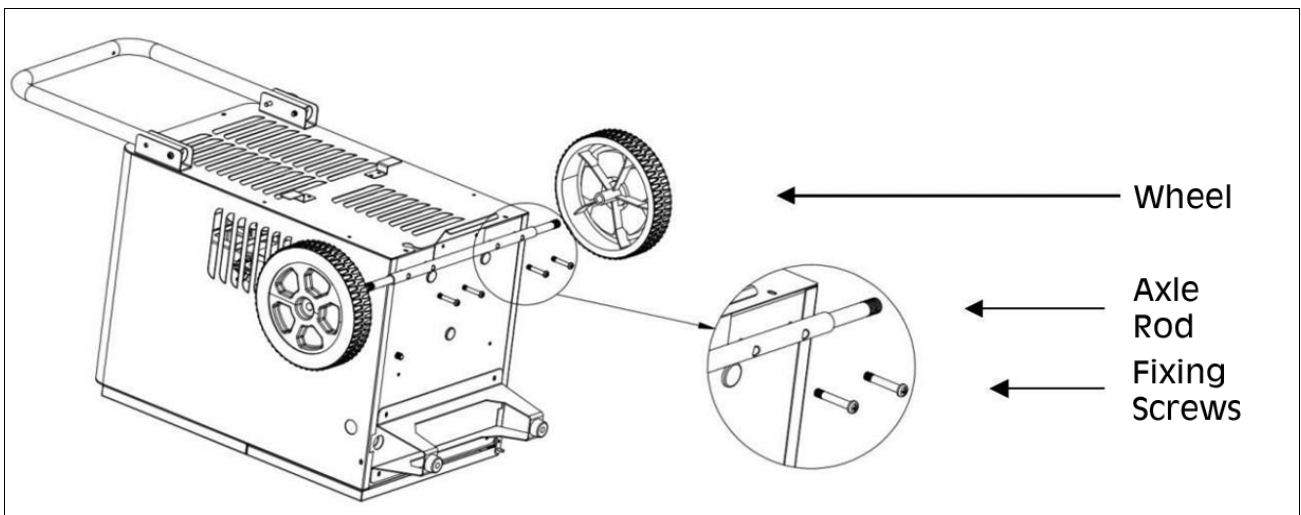

3. Once the wheels have been installed, place the machine in the upright position.

NOTE: Once assembly is complete, leave the machine to stand for 1 hour, this is for the refrigeration gases to settle before use.

OPERATION

CONTROL PANEL

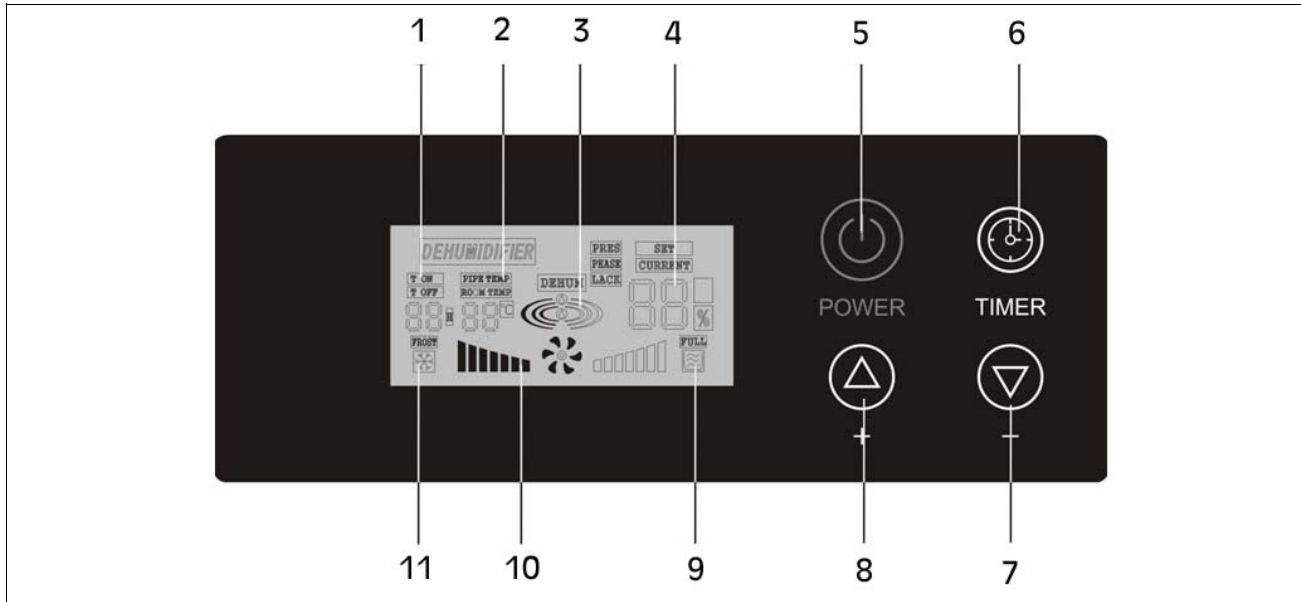

No.	Description	No.	Description
1	Timer	7	Subtract
2	Temperature	8	Add
3	Dehumidification	9	Full Water Tank
4	Humidity	10	Air Speed
5	Power	11	Defrosting
6	Timer Set		

Button	Operation Instructions
On/Off (Button 5)	Switches the machine On and Off
+ (Button 8)	Adjusts different set values in different states: 1: Increases the humidity value set (RH 10% to 95%) 2: Increases the timing (Hours) set (00 to 24)
- (Button 7)	Adjusts different set values in different states: 1: Decreases the humidity value set (RH 10% to 95%) 2: Decreases the timing (Hours) set (00 to 24)
Timer (Button 6)	Short press the button to launch a cycle to Off. Set On/Off timer and exit

WATER TANK & CONTINUOUS DRAINING

This machine has a 7 litre internal water tank. When the water tank is full, the machine will automatically shutdown at 5 litres and enter standby mode, on the LED display the 'Full Water Tank' will light up and an alarm will sound.

TO EMPTY THE TANK

1. Open the water tank door at the front of the machine.
2. Pull water tank out of the holding clips and empty.
3. Replace the water tank back in the holding clips and close the door.

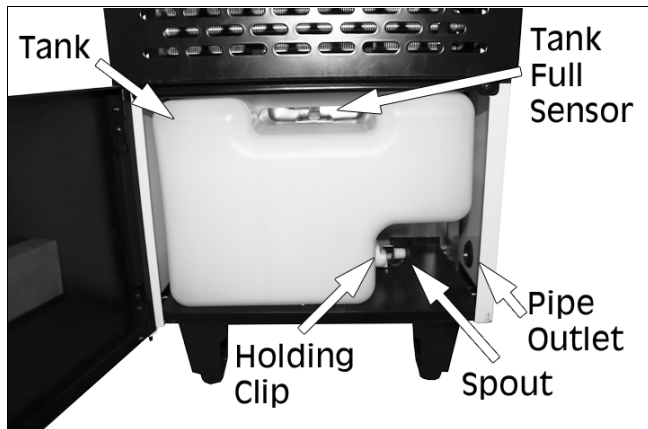

NOTE: The water tank full alarm will continually sound when the tank is removed and will not turn off until the tank is empty and correctly seated back in the machine.

PREPARATION FOR CONTINUOUS DRAINING

An external drainage pipe enables continuous dehumidifying without having to empty the water tank.

1. Extract the water tank from the machine and remove the plug from the water tank spout.
2. Locate the external drainage pipe and feed it through the drainage pipe outlet hole on the side of the machine.

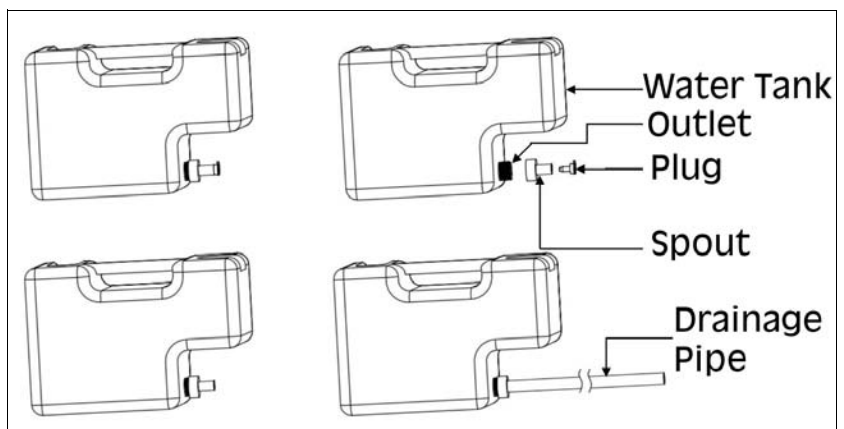

3. Place the end of the pipe onto the water tank spout and replace the tank back in the machine.
4. Place the external end of the pipe into a suitable receptacle/ drain ensuring that the end of the pipe is below the level of the outlet in the unit body.

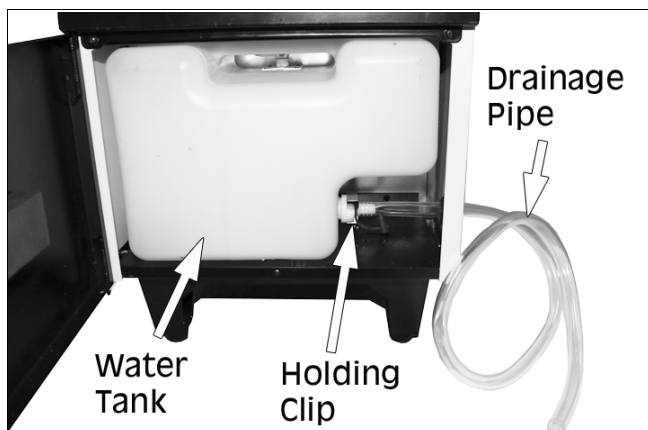

NOTE: If using a receptacle, make sure it is large enough as the machine can produce up to 50 litres of water in a 24 hour period.

NOTE: The pipe has an internal diameter of 13mm and is 100cm long.

NOTE: DO NOT submerge the end of the pipe in water, as this may cause water to be drawn back up into the machine.

TIMING AND ON/OFF FUNCTION

Setting the timer for both powering on and off will initiate the cycle timer mode.

SETTING OF TIMER - POWER ON

1. When the machine is powered off, press the "Timing" button.
2. The "Timing On" icon will flicker and the time set will flicker on the display screen.
3. Press the "+" or "-" buttons to adjust the timing. The dehumidifier will make a sound once the button is pressed. The time set will increase or decrease by "1", holding the button for 2 seconds will continually increase or decrease the time.
4. Once the required time is set, non-action of the buttons for 10 seconds the dehumidifier will accept the new setting and the "Timing On" icon will flicker (Ranging from 0 to 24 hours, and 0 hours as default).

SETTING OF TIMER - POWER OFF

1. When the machine is powered on, press the "Timing" button.
2. The "Timing Off" icon will flicker and the time set will flicker on the display screen.
3. Press the "+" or "-" buttons to adjust the timing. The dehumidifier will make a sound once the button is pressed. The time set will increase or decrease by "1", holding the button for 2 seconds will continually increase or decrease the time.
4. Once the required time is set, non-action of the buttons for 10 seconds the dehumidifier will accept the new setting and the "Timing Off" icon will flicker (Ranging from 0 to 24 hours, and 0 hours as default).

HUMIDITY CONTROL

- When the rooms humidity value is 3% lower than the set humidity on the machine, the compressor will shut down, the fan will delay shut down for 3 minutes and then shut down; and when it is 3% higher than the humidity value set on the machine, both the fan and compressor will start to operate.
- When the humidity is set at the minimum value (10%), the machines default will enter the continuous dehumidifying mode.

- When started, the compressor will start 3 seconds later and when it is shut down, the fan will run for 3 seconds.
- If a fault of the humidity sensor occurs, the machine will turn to the continuous dehumidifying mode.
- If a fault of the coil sensor occurs, the machine will turn to the timing defrosting mode (See Defrosting Mode).

PROTECTION FUNCTION

- Once shut down, the compressor will take 3 minutes to restart. Quick start is available for the first power-on.
- **Power off memory:** For abrupt power outage or accidental unplugging, the machine will automatically return to the operating state right before the 'incident', and continue at that state for the next power-on.

DEFROSTING MODE

Defrosting Mode	Description	
Automatic Defrosting	Sensor at Normal State	1: It enters this mode when the compressor runs constantly for 30 minutes and the coil temperature is tested to be $< \text{or} = 1^{\circ}\text{C}$. 2: In defrosting, the compressor stops running, the fan continues running and the defrost light is on.
Timing Defrosting	In this mode, the machine will defrost for 8 minutes and then switch to standby mode.	

MAINTENANCE



WARNING: ALWAYS UNPLUG THE DEHUMIDIFIER BEFORE PERFORMING ANY CLEANING OR MAINTENANCE OPERATIONS.

CLEANING THE CABINET

- Use a soft damp cloth to clean the exterior.
- Never use harsh chemicals or abrasive cleaning agents as these may damage the casing finish.
- Clean the water tank and its cover regularly to prevent mould build up.

CLEANING THE CARBON AIR FILTER

1. At the front of the machine, pull the filter upwards, using the tab.
2. Wash the filter under running water to remove any dust and dirt.
3. Allow the filter to dry naturally.
4. Refitting is the reverse process.

The frequency depends on the duration and the level of dust in the environment. If the machine is being used regularly, it is recommended that you clean the filter every 2 weeks.

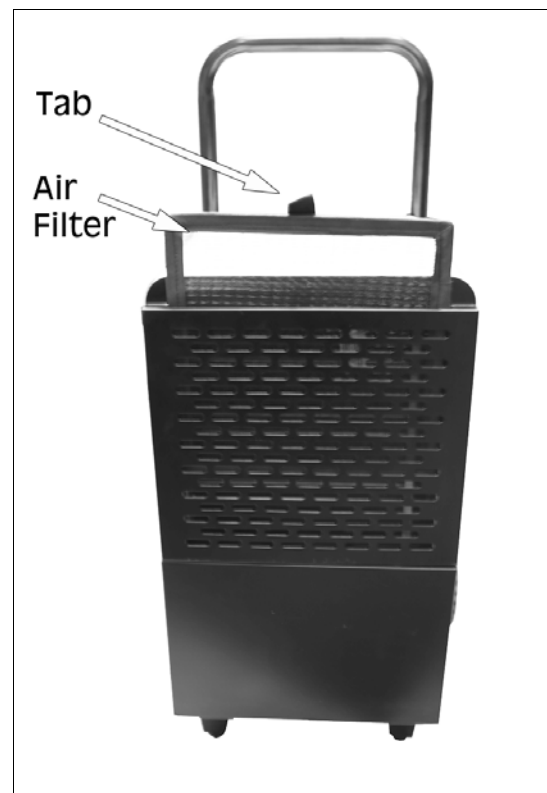

STORAGE

- Unplug from the mains socket.
- Empty any water from the tank.
- Clean and reinstall the filter.
- Cover the dehumidifier to prevent dust getting into the workings.

TROUBLESHOOTING

	Cause	Solution
No operation (Shown as no power)	Power outage	Check if the power supply is in working order. Confirm the plug is correctly inserted in the power socket.
	Fuse in plug or fuse board blown	Replace the relevant fuse.
No operation (Shown as power on)	Environmental humidity lower than the set value	Reset humidity setting according to the demand.
	The machine is defrosting	Wait for defrosting to complete.
Dehumidifier function not effective	If a door or window are open	Close the door or window.
	Room temperature is too low	Do not use the dehumidifier.
	Room temperature too high, humidity too low.	In dry conditions the dehumidification ability will reduce.
	Air filter blocked.	Remove any dirt or obstruction from the air intake.
Noise is abnormal during operation	Dehumidifier is positioned incorrectly.	Check that dehumidifier is placed on a flat level surface.
	Air filter blocked.	Remove any dirt or obstruction from the air intake.
	There is a 'tittering' sound.	This is the flow of the refrigerant, which is a normal phenomenon.
Water Leak	Connection of drainage pipe become loose.	Check pipe connection.
	Drainage system is blocked.	Remove obstacle and straighten out drainage pipe.
Frosting Occurs	The ambient temperature is low and the machine is waiting for defrost.	This is a normal phenomenon and the dehumidifier has an automatic defrost function.

DISPLAY CODES

Display Code	Instruction	Action
E1	Fault with coil sensor	See Defrosting Mode.
E2/E3	Fault with humidity and/or temperature sensor	Replace temperature and humidity sensor.
EE	Refrigerant leakage	Contact CLARKE service department if EE signal remains.

ELECTRICAL DIAGRAM

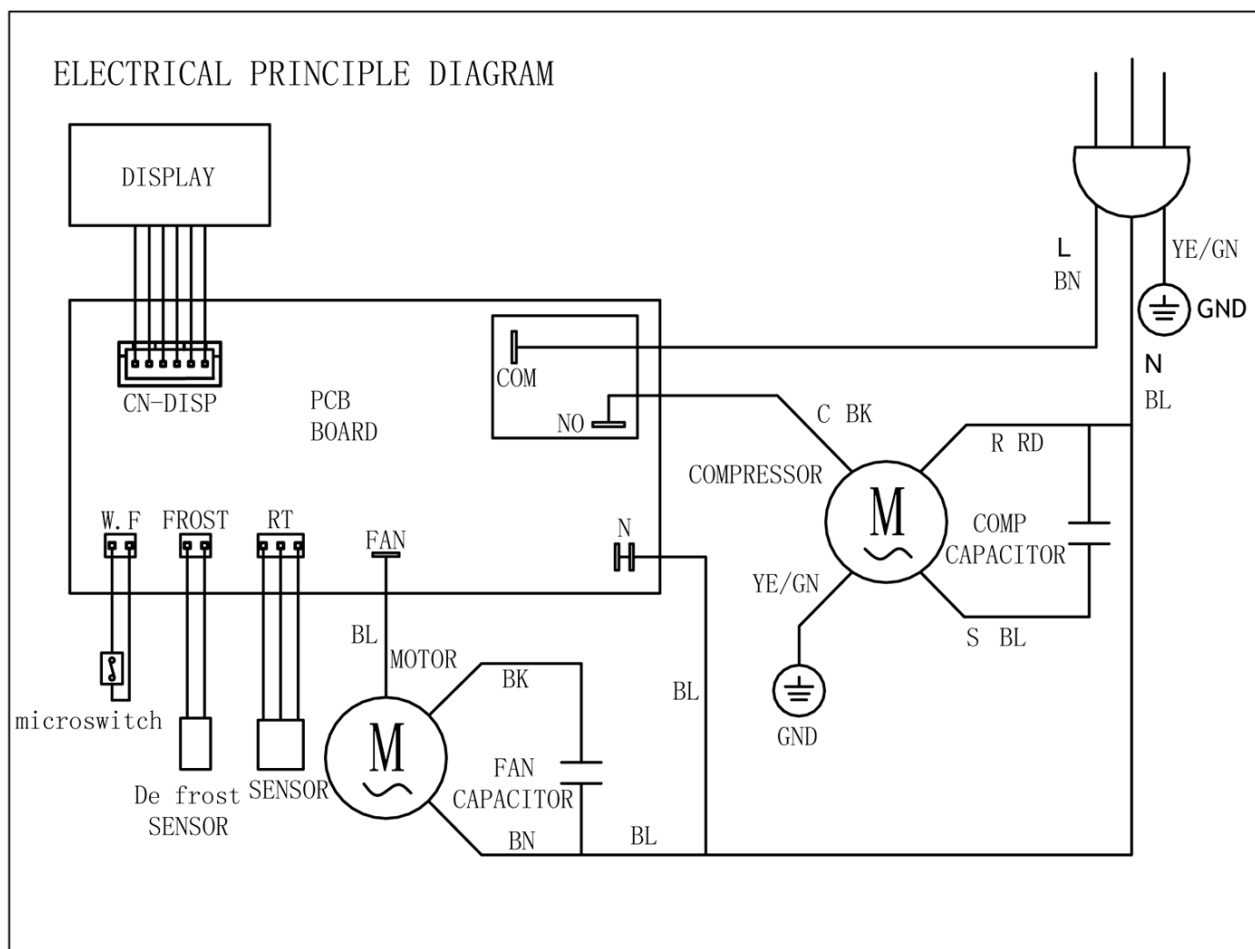

COMPONENT PARTS DIAGRAM

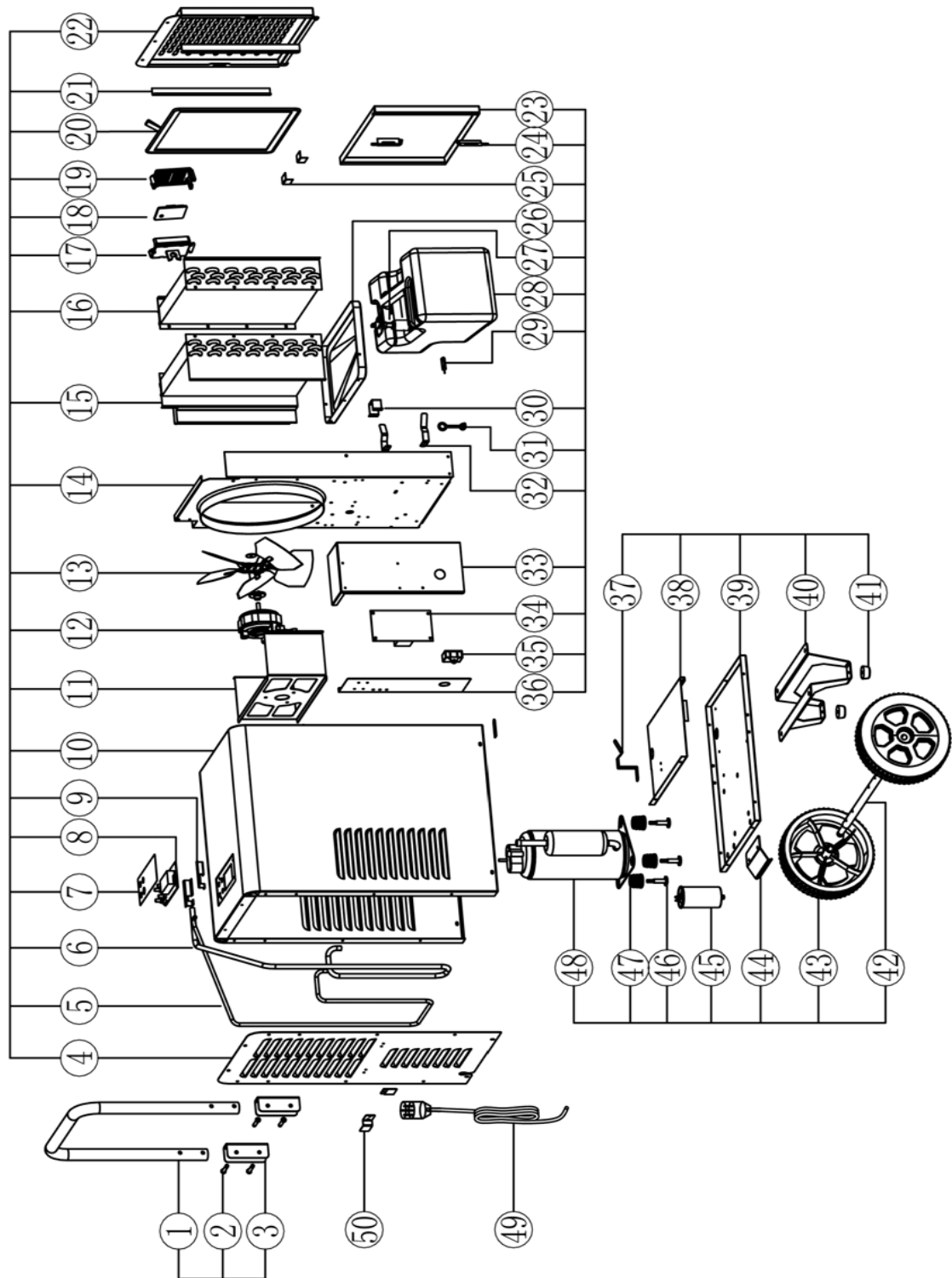

COMPONENT PARTS LIST

No	Description
1	Handle
2	4 x Bolt & Nut, M6 x 35
3	Handle Bracket
4	Back Cover
5	Discharge Pipe
6	Suction Pipe
7	Control Panel Label
8	Control Panel
9	Control Panel Holder
10	Main Body Shell
11	Motor Bracket
12	220V/50Hz Fan Motor
13	250mm Fan Blade
14	Partition Plate
15	Condenser
16	Evaporator
17	Sensor Bracket
18	Temp. & Humidity Sensor
19	Sensor Cover
20	Carbon Air Filter
21	Front Cover Bracket
22	Front Cover/Grill
23	Water Tank Door
24	Hinge Bolt
25	Door Hinge
26	Water Drip Pan
27	Water Level Switch
28	Water Tank
29	Magnetron Switch
30	Magnetron Switch Holder
31	Water Tank Plug
32	Water Tank Bracket
33	Control Box

No	Description
34	Power Strip
35	Fan Motor Capacitor
36	Control Box Side Plate
37	Water Tank Bracket
38	Water Tank Support Plate
39	Main Body Base Plate
40	Foot Bracket
41	Foot Pad
42	Wheel Axle, 16mm x 462mm
43	Wheel
44	Foot Rest
45	Compressor Capacitor
46	Compressor Bolt, M8 x 40
47	Compressor Mat
48	Compressor
49	Power Cable
50	Power Cable Storage Clip

DECLARATION OF CONFORMITY - UKCA



Clarke[®]
INTERNATIONAL

Hemnall Street, Epping, Essex CM16 4LG

DECLARATION OF CONFORMITY

This is an important document and should be retained.

We hereby declare that this product(s) complies with the following statutory requirement(s):

Electromagnetic Compatibility Regulations 2016

Supply of Machinery (Safety) Regulations 2008

The Restriction of the Use of Certain Hazardous Substances in Electrical Electronic Equipment regulations 2012

The following standards have been applied to the product(s):

EN 55014-1:2017/A11:2020, EN 55014-2:2015, EN 60335-2-40:2003+A13:2012,

EN 60335-1:2012+A2:2019, IEC 62321-1:2013, IEC 62321-2:2013, IEC 62321-8:2017,

IEC 62321-3-1:2013, IEC 62321-5:2013, IEC 6231-4:2013+AMD1:2017CSV,

IEC 62321-7-2:2017, IEC 62321-7-1:2015, IEC 62321-6:2015, ISO 17075:2017.

The technical documentation required to demonstrate that the product(s) meet(s) the requirement(s) of the aforementioned legislation has been compiled and is available for inspection by the relevant enforcement authorities.

The UKCA mark was first applied in: 2022

Product Description: 50L Industrial Dehumidifier (110V)

Model number(s): IDH50L110V

Serial / batch Number: N/A







Date of Issue: 05/04/2022

Signed:

J.A. Clarke

Director

ASSOCIATED 110V PRODUCTS

<p>EURO5 Generator - PG3800ADV</p>	<p>12" Ventilator/Air Mover - CON305</p>	<p>2.8kW Electric Fan Heater- Devil 3003</p>
		
<ul style="list-style-type: none"> • Max Output:3000W • 5.6HP Petrol Engine • Dims(LWH):600mm x 480mm x 445mm • Part No. 8857854 	<ul style="list-style-type: none"> • Fan Dia.: 12" (300mm) • Air Flow: 3900m3/h • Dims(LWH):375mm x 386mm x 430mm • Part No. 3230480 	<ul style="list-style-type: none"> • Adjustable Thermostat • Weight: 6.15kg • Dims(LWH):400mm x 260mm x 390mm • Part No. 6925125
<p>Transformer - CTR3000</p>	<p>110V Extension Lead - C14EC</p>	<p>Twin LED Work Light & Tripod - SMD84T/110</p>
		
<ul style="list-style-type: none"> • BS4343 Dual Sockets • 3300va with Overload Circuit Protection • Dims(LWH):236mm x 195mm x 265mm • Part No. 3220785 	<ul style="list-style-type: none"> • 16 Amp • 14 Metres • Part No. 3220825 	<ul style="list-style-type: none"> • 2 x 1650 Lumen Floodlights • Internal or External Use IP54 • Adjustable Height upto 1720mm • Part No. 4003640

A SELECTION FROM THE VAST RANGE OF

Clarke®

QUALITY PRODUCTS



AIR COMPRESSORS

From DIY to industrial, Plus air tools, spray guns and accessories.

GENERATORS

Prime duty or emergency standby for business, home and leisure.

POWER WASHERS

Hot and cold, electric and engine driven - we have what you need

WELDERS

Mig, Arc, Tig and Spot. From DIY to auto/industrial.

METALWORKING

Drills, grinders and saws for DIY and professional use.

WOODWORKING

Saws, sanders, lathes, mortisers and dust extraction.

HYDRAULICS

Cranes, body repair kits, transmission jacks for all types of workshop use.

WATER PUMPS

Submersible, electric and engine driven for DIY, agriculture and industry.

POWERTOOLS

Angle grinders, cordless drill sets, saws and sanders.

STARTERS/CHARGERS

All sizes for car and commercial use.

PARTS & SERVICE: 0208 988 7400

Parts Enquiries
Parts@clarkeinternational.com

Servicing & Technical Enquiries
Service@clarkeinternational.com

SALES: UK 01992 565333 or Export 00 44 (0)1992 565335

Clarke INTERNATIONAL Hemnall Street, Epping, Essex CM16 4LG
www.clarkeinternational.com